

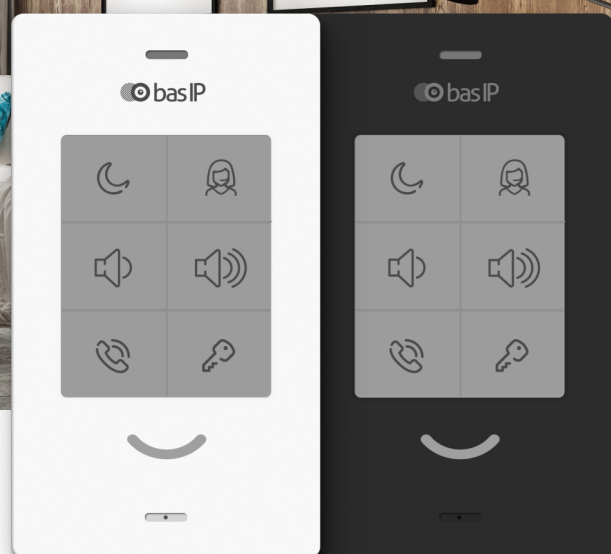

SP-03

IP AUDIO HANDS-FREE



Description

IP audio hands-free with support for SIP, P2P and internal BAS-IP protocol.











Equipped with buttons to quickly call the concierge, open the lock, control the Do Not Disturb mode, and electronically adjust the volume.

Also, the SP-03 has a three-color light indicator of the status and operating modes of the device.

Specifications

Number of VoIP accounts supported	1
Supported protocol type	IPv4
Network connection	1 PoE port IEEE 802.3af
Power supply	1 PoE IEEE 802.3af port and 1 +12 V DC connection port
Supported codec type	G.711μ / A
Additional function	Doorbell
Audio transmission method	Full Duplex
Number of control keys	6
Configuration and programming method	WEB-interface
Colors	White / Black
Overall dimensions	183 × 105 × 28 mm
Installation Type	Wall mounted

Main features

-  Concierge calling
-  Flexible system setup
-  Calling the lift to the floor
-  Quick installation
-  Emergency alert
-  Door bell connection
-  Do Not Disturb mode
-  Touch Buttons
-  Easy to replace with a monitor
-  PoE powered

Functional capabilities

Calls to the Concierge Monitor

Call forwarding

SIP 2.0 protocol support, for organizing communication with any VoIP equipment supporting this protocol

Supports internal BAS-IP protocol

DND

Mute

Displaying various device statuses using LEDs

Opening the lock of the called panel

6 volume levels

Color variations

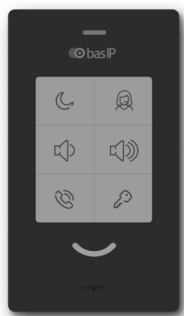

BLACK

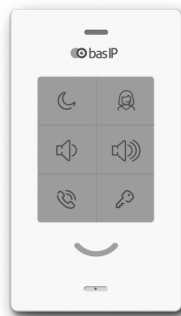

WHITE

Appearance and mechanical mounting

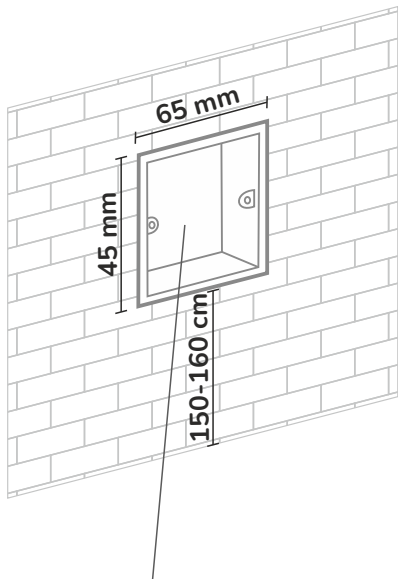

Mounting box

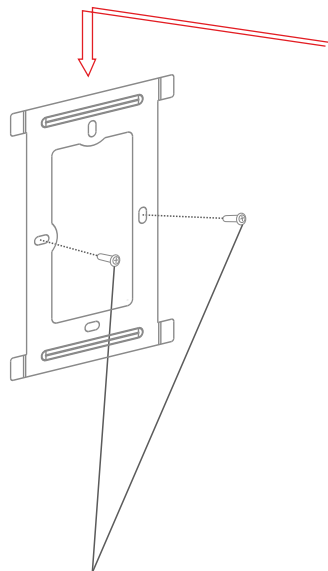

Screws

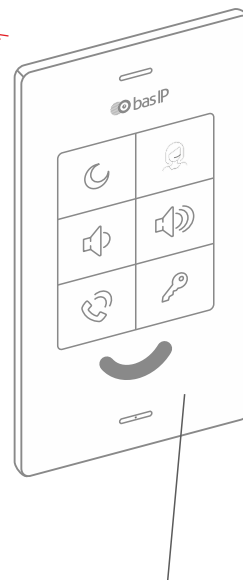

Device